



5

+



6

+



7

+



8

A

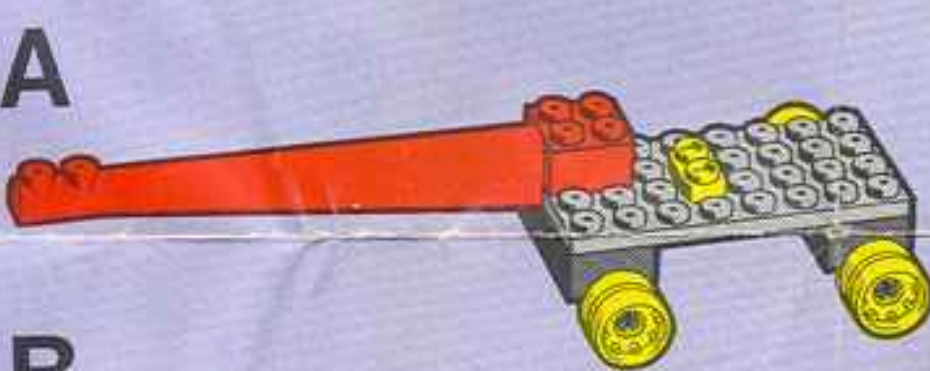

B

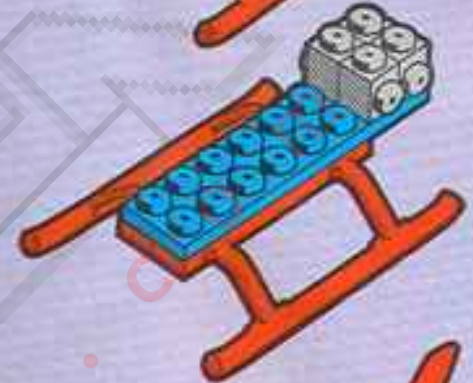
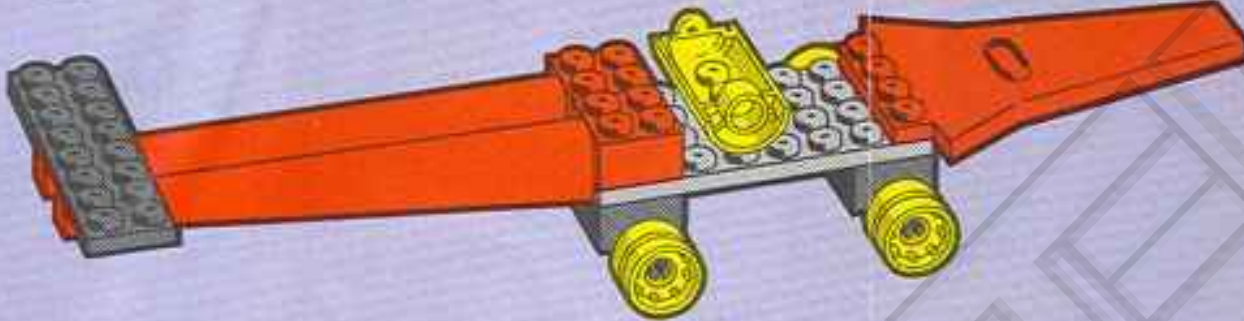

C

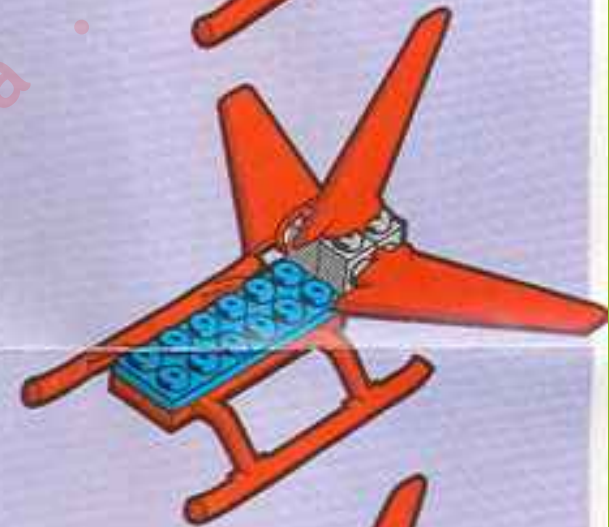
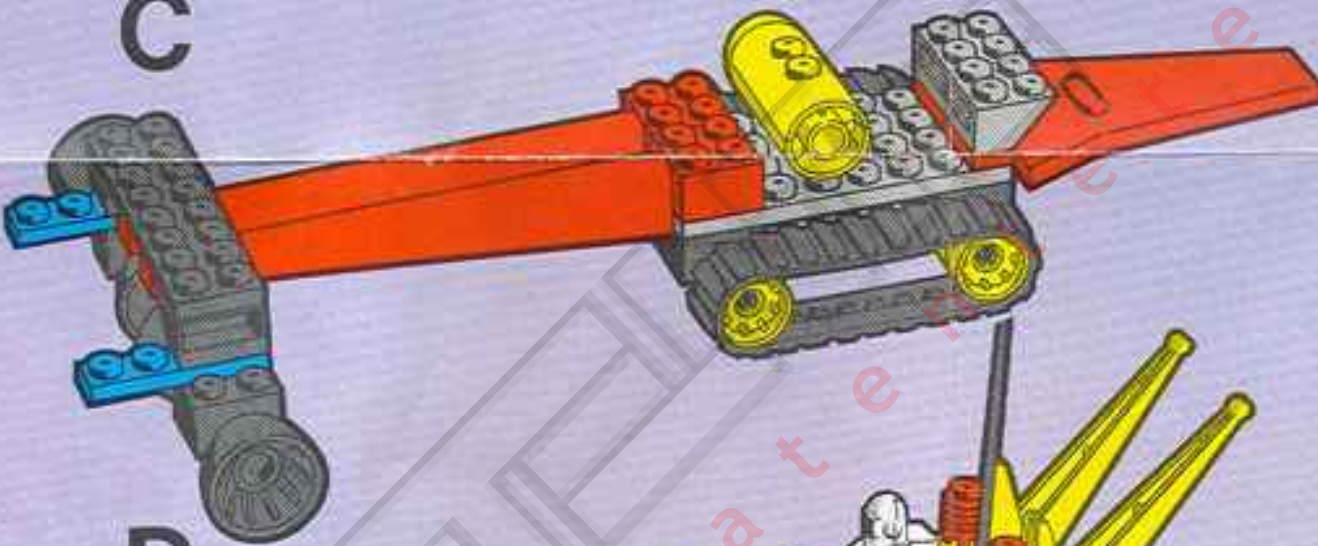

D

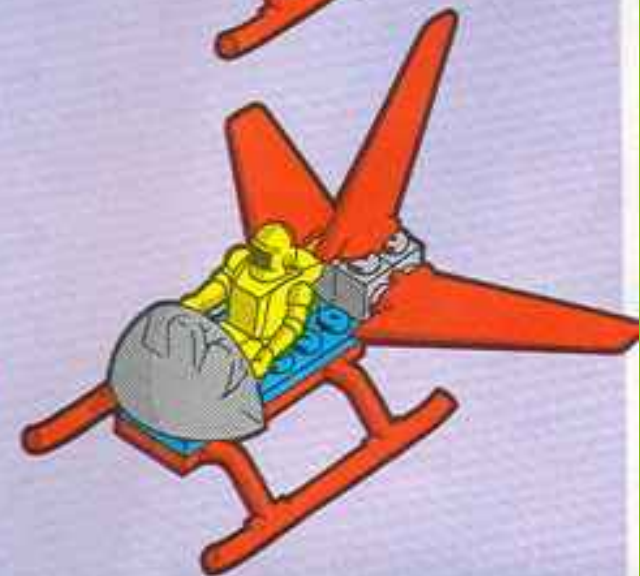
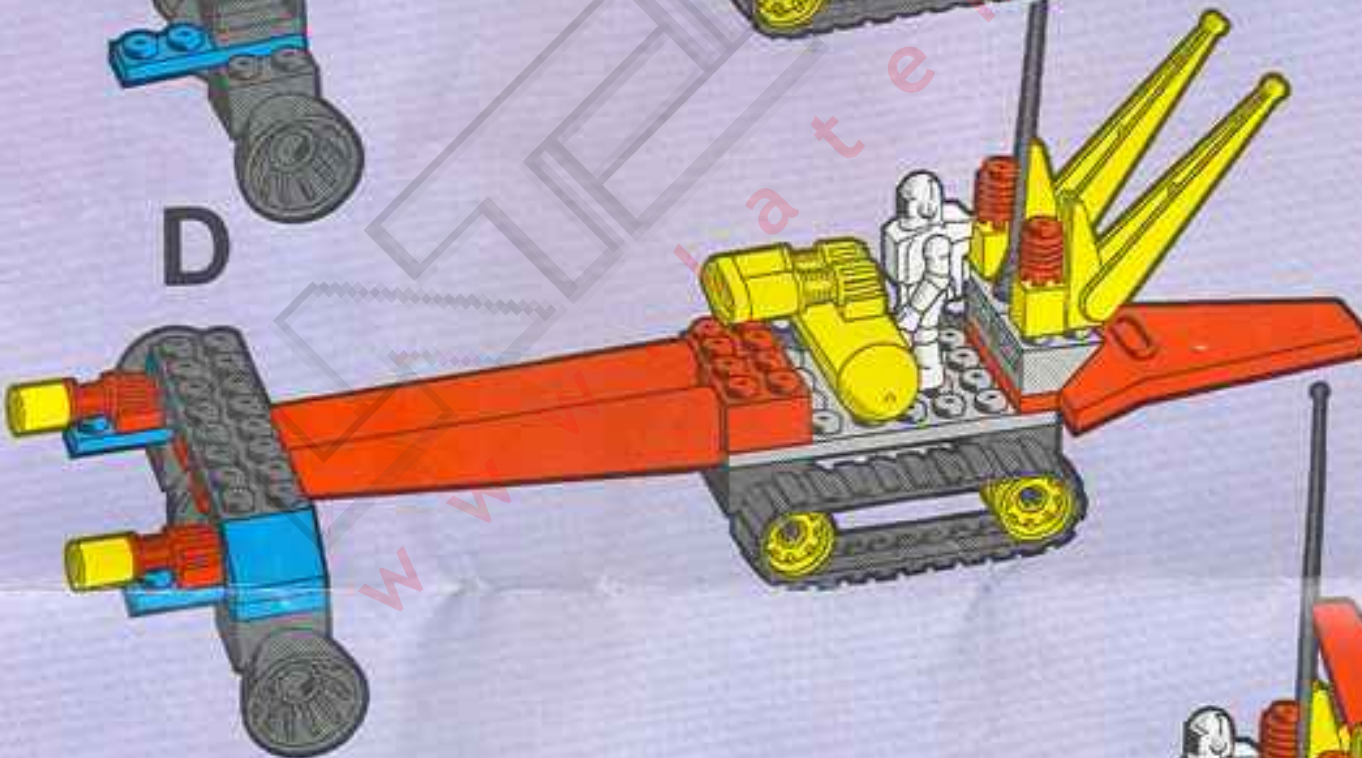

E

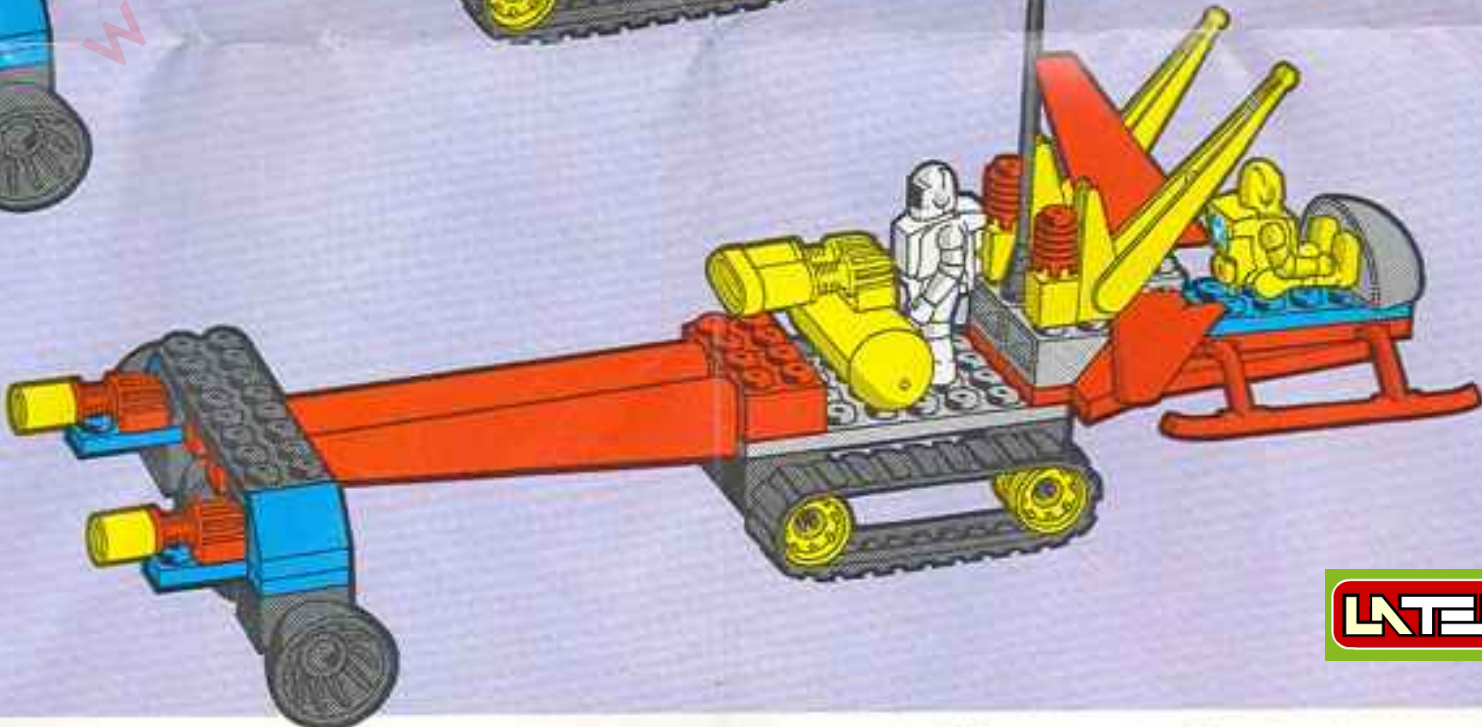



**TENTE**

*-combi*

COMBINACIONES · COMBINATIONS · COMBINAISONS · COMBINAZIONI · BAUMOEGLICHKHEITEN



+



A

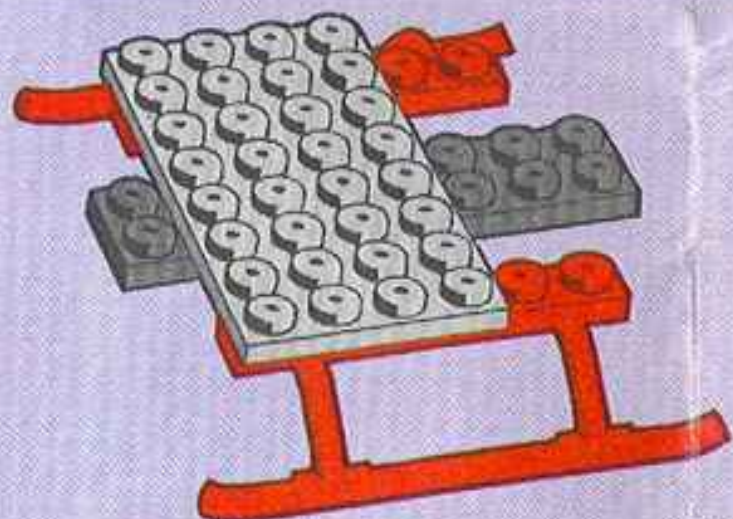

B

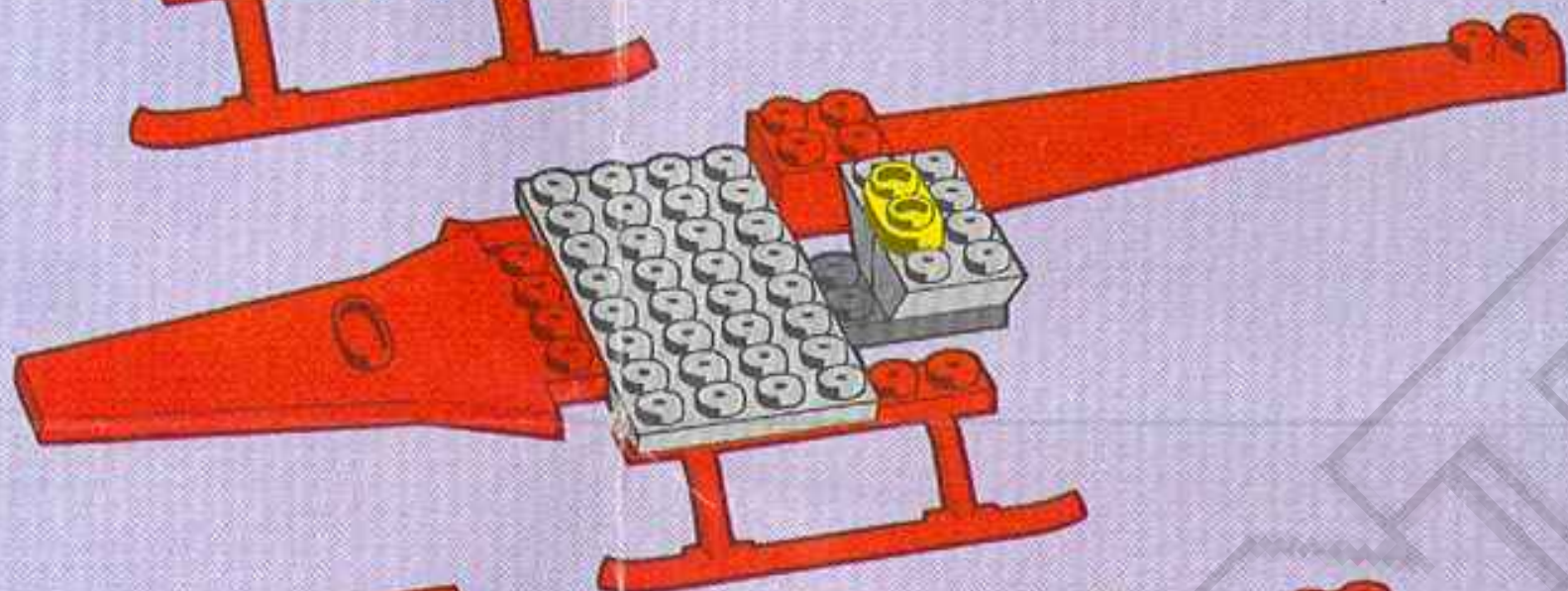

C

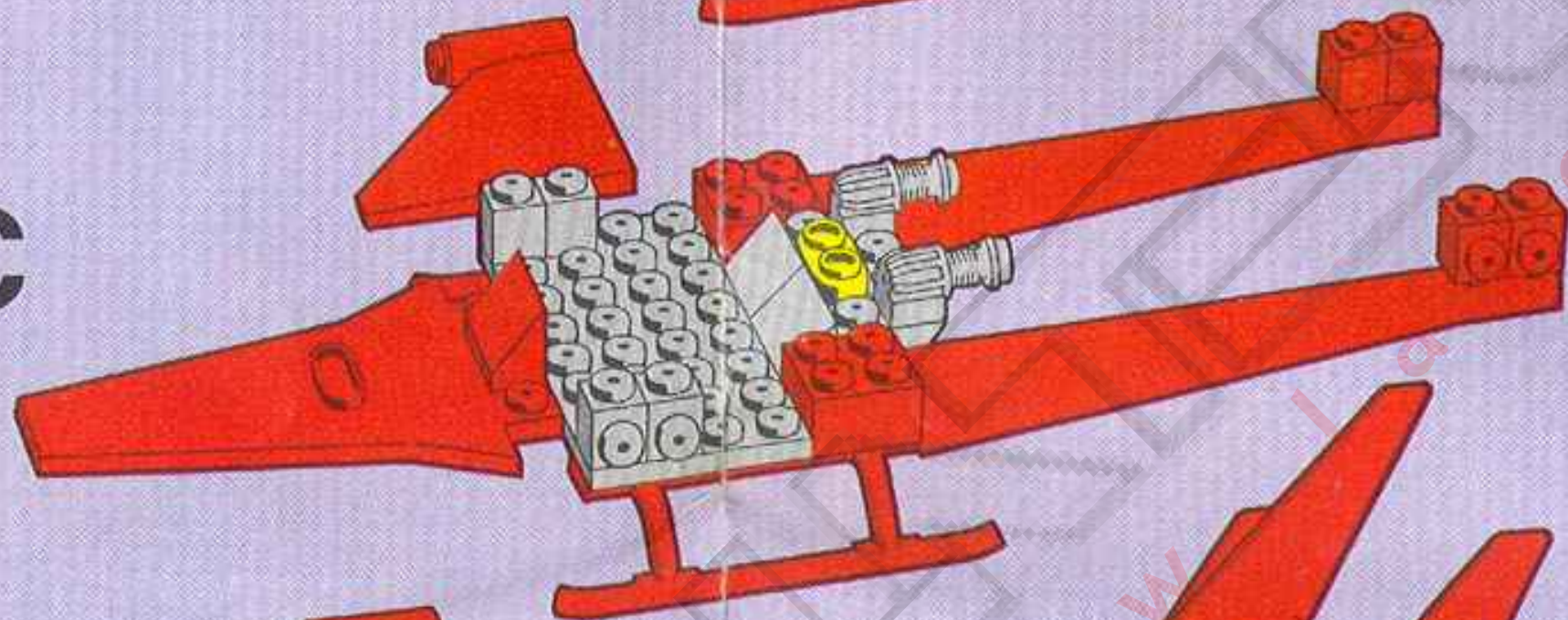

D

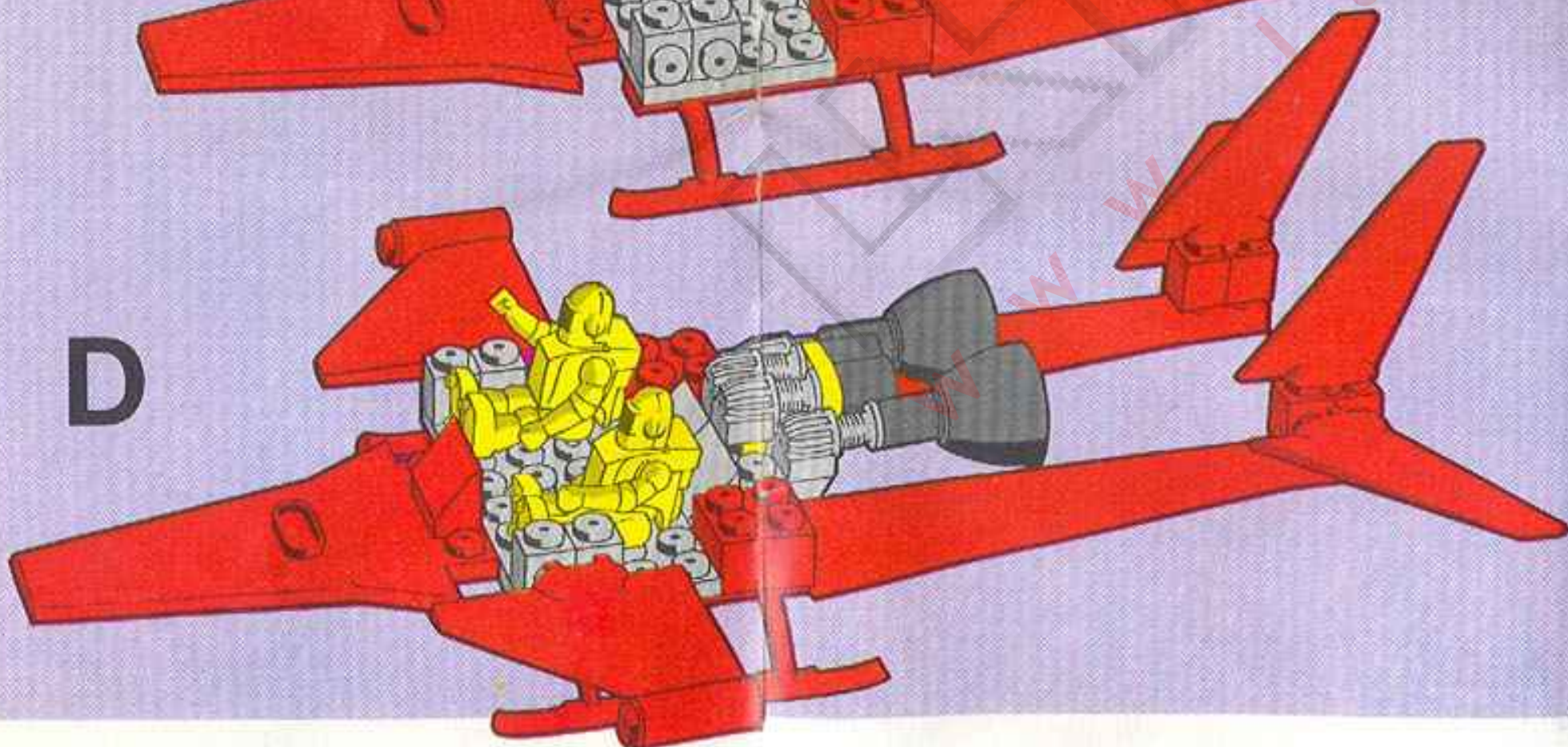

+



A

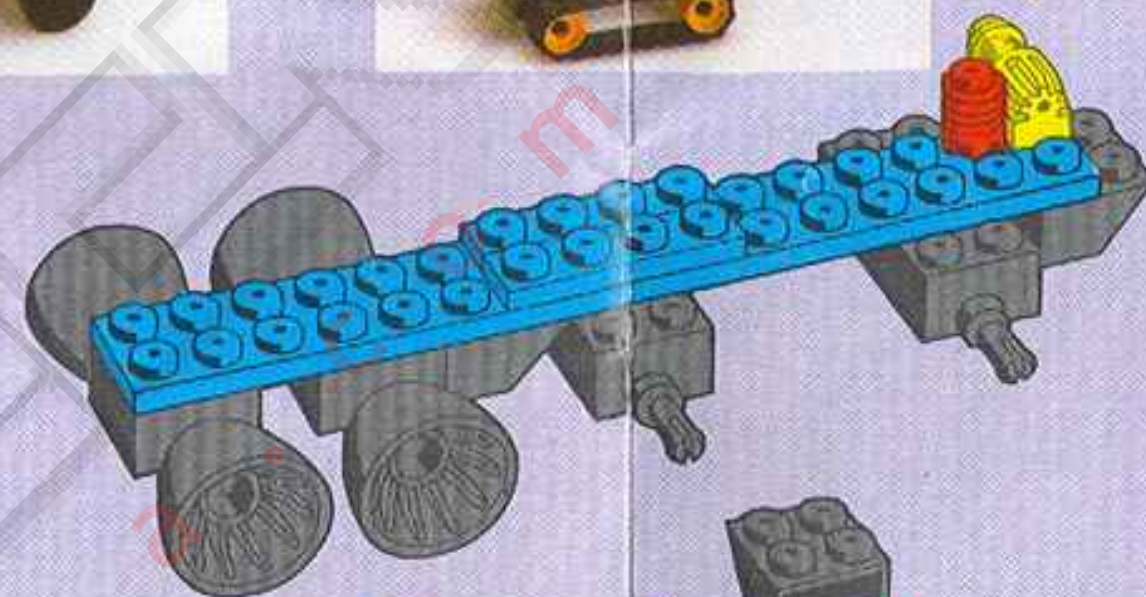

B

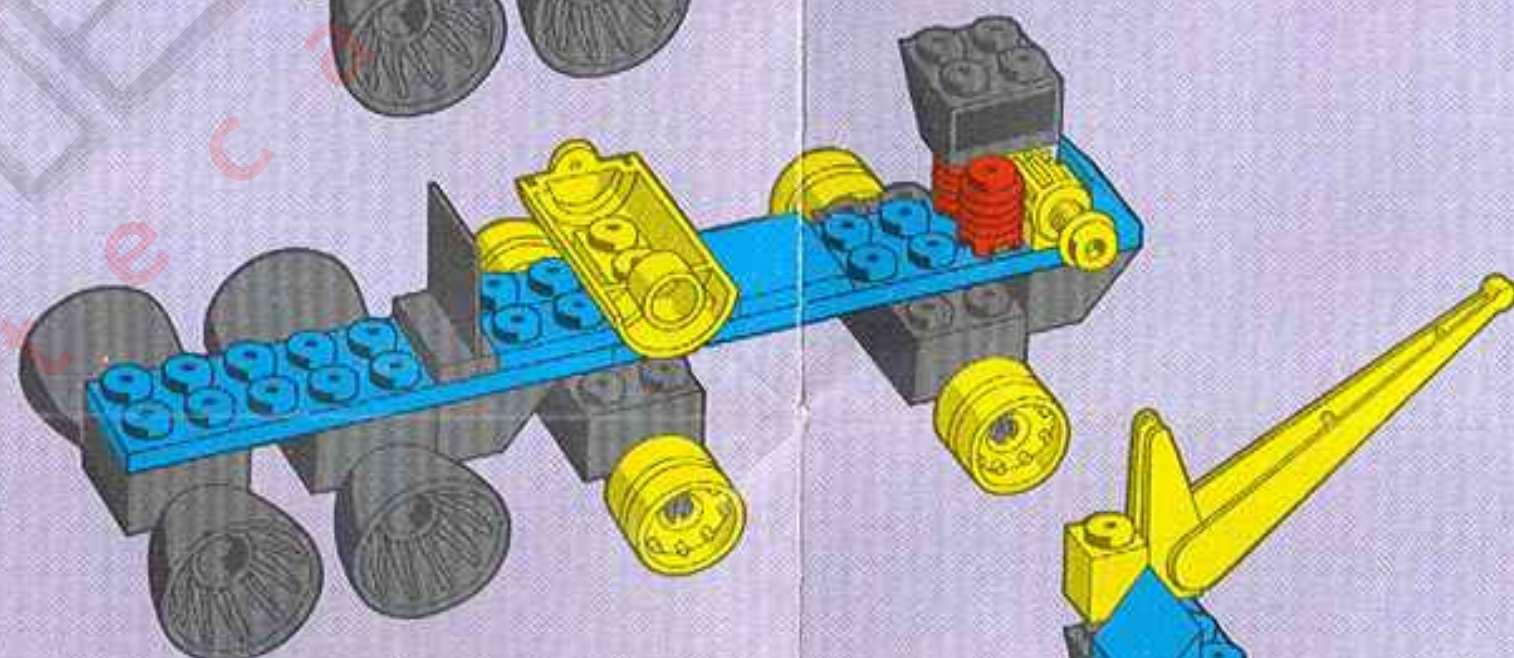

C

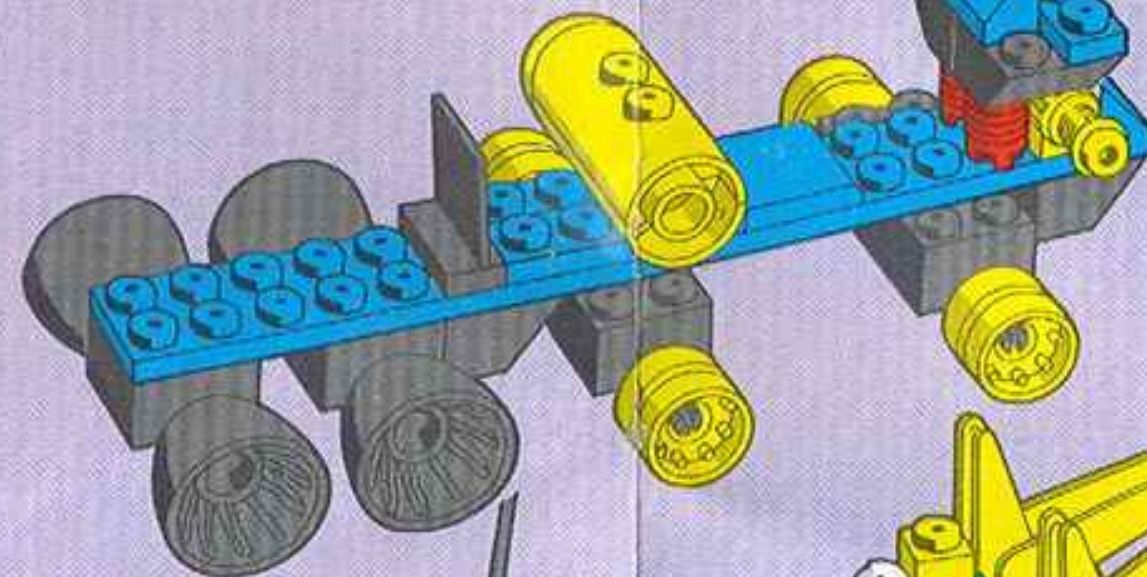

D

