

Poner atención en la colocación de las pilas, orientándolas como muestra el dibujo. Sólo deben utilizarse pilas alcalinas tipo "botón" Ref. IEC/LR-44 de 1,5 V.
Se recomienda colocar y sustituir las pilas por un adulto, con el fin de que no queden al alcance de los niños pequeños. Accionando el interruptor del módulo a la posición ON, se encienden las luces alternativamente y emite un sonido intermitente. Para periodos de inactividad superiores a dos meses, es aconsejable retirar las pilas del módulo.

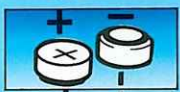

Take care when inserting the batteries to place them in the same direction as in the drawing. Use only 1.5V, button type alkaline batteries, Ref. IEC/LR-44.
We recommend that batteries be removed and replaced by an adult, so as to keep them out of the reach of small children. When the module switch is in the ON position the lights go on alternatively and emit an intermittent signal. For periods of inactivity of more than two months, it is advisable to remove the batteries from the module.



Faire bien attention à la mise en place des piles; les orienter comme l'indique le dessin. Doivent seules être utilisées des piles alcalines, type "bouton", ref. IEC/LR-44, de 1,5 V.
Il est recommandé que mise en place et remplacement des piles soient faits par un adulte, afin de ne pas mettre celles-ci à la portée des jeunes enfants.

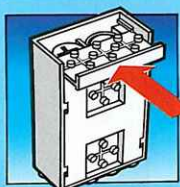

Si l'on place l'interrupteur du module sur la position ON, si accendono alternativamente le luci ed emette un suono intermittenente. Per periodi di inattività di oltre due mesi, è consigliabile togliere le pile dal modulo.

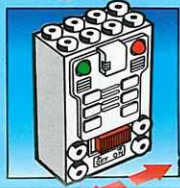

Collocare le pile con attenzione, orientandole come indica il disegno. Si debbono utilizzare solamente pile alcaline tipo "bottoni" IEC/LR-44 da 1,5 V. Si raccomanda che sia un adulto colui che metta e sostituisca le pile, affinché non rimangano alla portata dei bambini piccoli.

Beim Einlegen der Batterien nach der Zeichnung vorgehen. Es dürfen nur Alkali-Knopfbatterien verwendet werden. Art-Nr. IEC/LR-44; 1,5 V. Es wird empfohlen, dass das Einlegen und Auswechseln der Batterien von Erwachsenen vorgenommen wird, damit die Batterien nicht in die Hände von Kleinkindern gelangen. Wird der Schalter der Baueinheit in die ON-Stellung gebracht, leuchten die Lichter abwechselnd auf und wird ein intermittierender Ton hörbar. Wird das Gerät während mehr als zwei Monaten nicht benutzt, empfiehlt es sich, die Batterien aus der Baueinheit herauszunehmen.

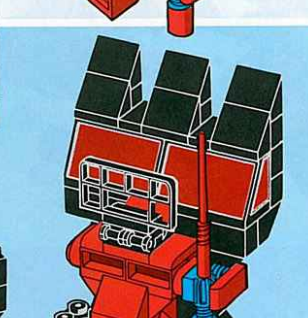
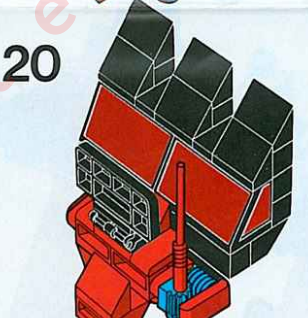
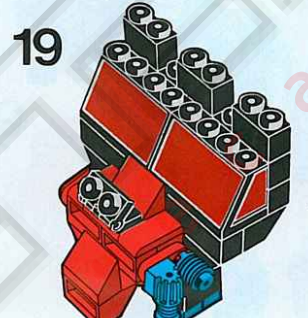
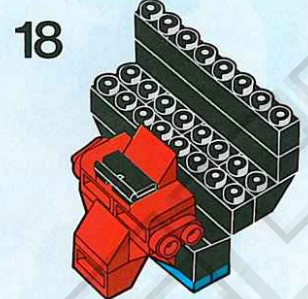
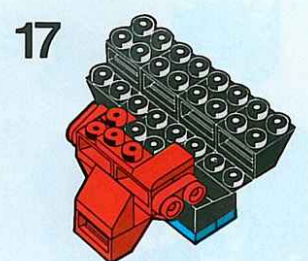
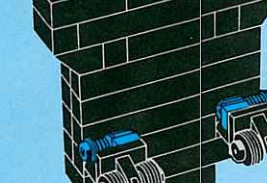
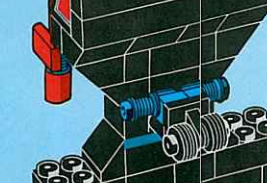
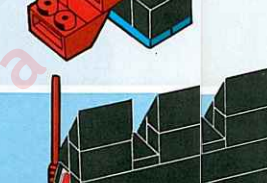
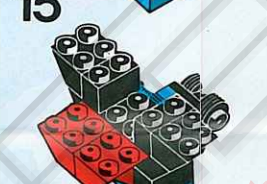
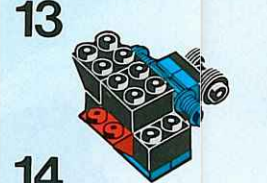
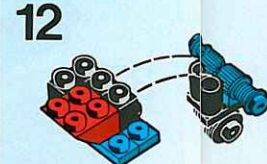
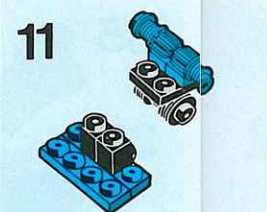
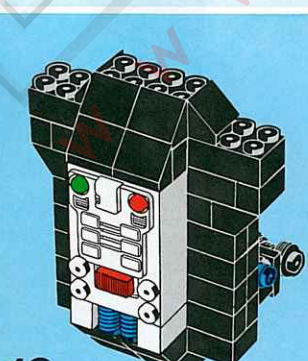
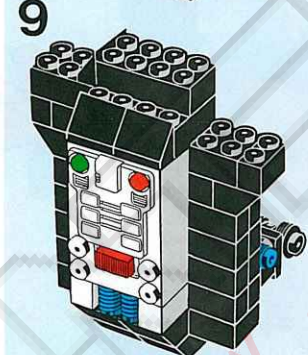
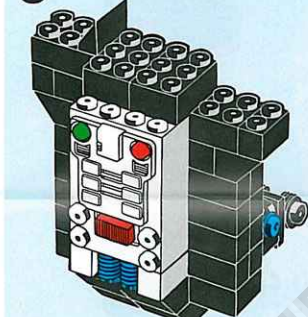
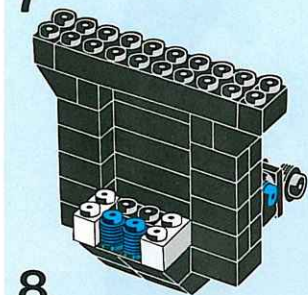
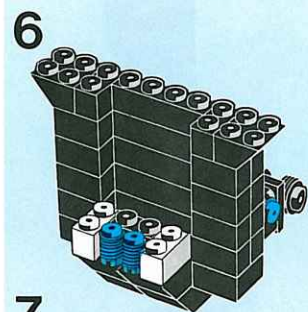
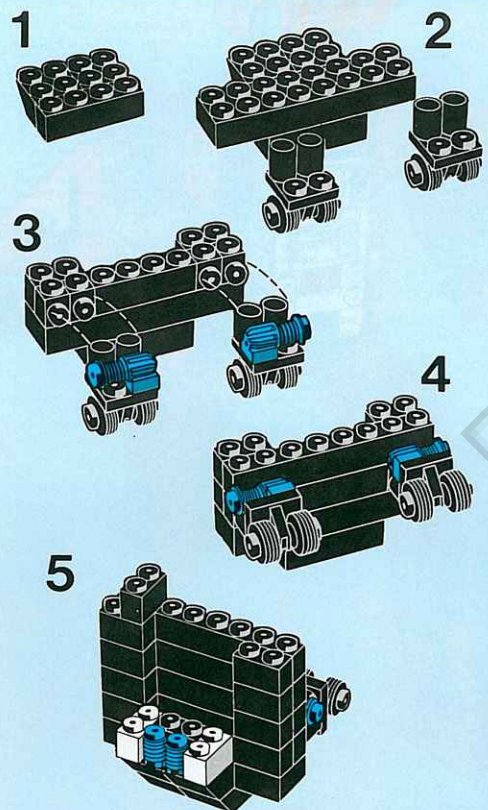

21=20+10

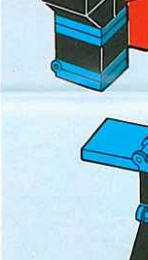
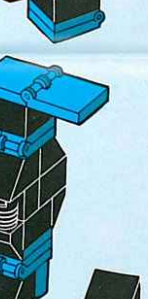
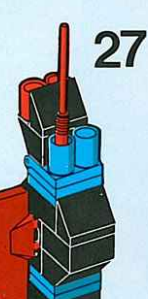

34=33+27+21

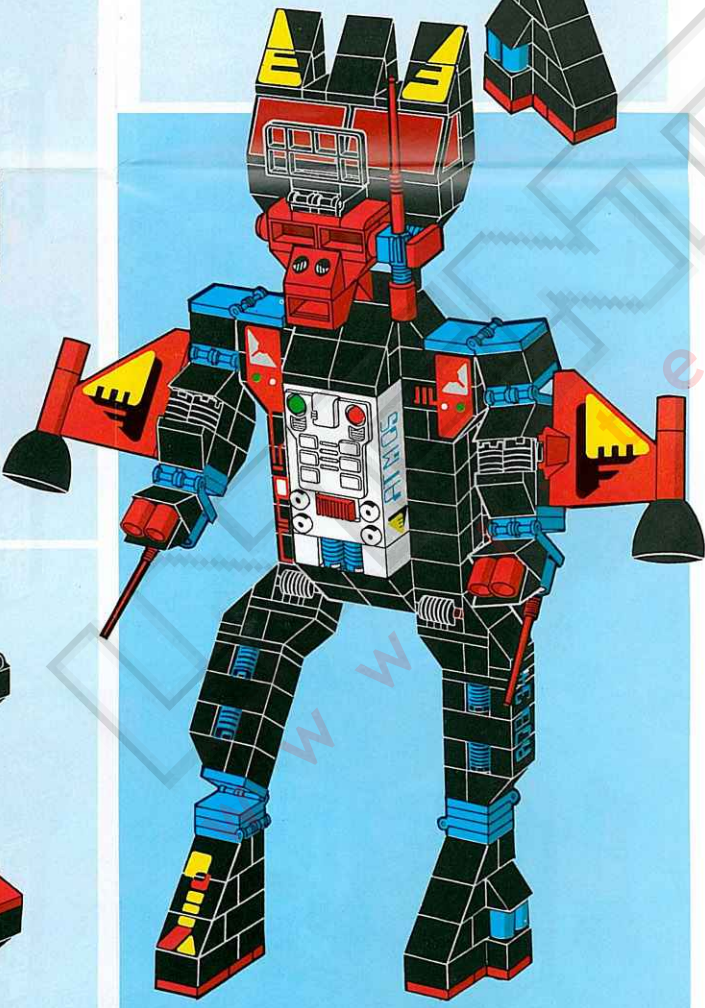
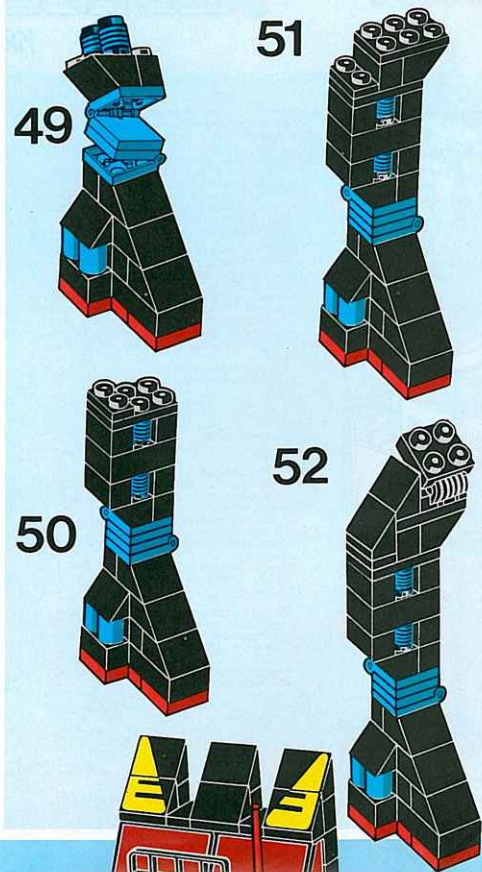
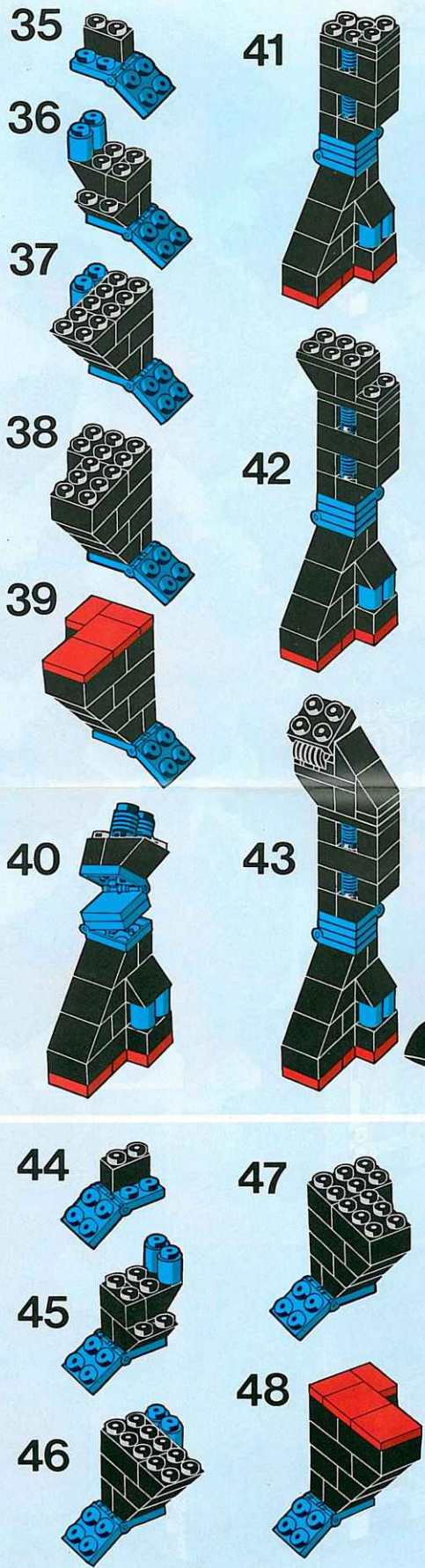

53=52+43+34

KRATOR
0798



ROBLOCKS es un juego de construcción compuesto por muchas piezas. Debido a los movimientos articulados durante el juego, algunas partes deben soportar un cierto esfuerzo, por lo que es conveniente acoplar muy bien unas piezas con otras.

SUPERTRANSFORMABLES
Los ROBLOCKS son transformables y están compuestos por piezas normales de TENTE, que permiten el poder modificar los modelos realizando creaciones propias. También se pueden conseguir modelos espectaculares utilizando los contenidos de varias cajas o piezas de TENTE "MAR", "AIRE", "COSMIC", etc.
TODAS LAS PIEZAS DE TENTE SON INTERCAMBIABLES.

ROBLOCK is a construction toy composed of many different pieces. Due to the articulated movements and the various positions that the Roblocks can assume during the play, some parts must bear greater stress than others. Therefore it is very important to make sure that the blocks are securely connected before play begins.

SUPERTRANSFORMABLES
ROBLOCK are truly transformable, and they are composed of regular TENTE blocks. This allows you to use existing TENTE blocks to make your own creations. You can build dramatic models by combining the contents of several TENTE sets, Tente Sea, Tente Air, Tente Cosmic, etc.
ALL THE TENTE BLOCKS ARE INTERCHANGEABLE.

ROBLOCK est un jeu de construction composé de nombreuses pièces. Les parties articulées devant supporter un certain effort, il est recommandé de bien fixer les pièces les unes aux autres.

SUPERTRANSFORMABLES
Les ROBLOCKS sont transformables et sont composés de pièces normales de la gamme TENTE ce qui permet de modifier les modèles existants et de créer ainsi des modèles originaux. On obtiendra des créations plus spectaculaires encore en utilisant les contenus des boîtes TENTES Air, Mer, Cosmic, etc.
TOUTES LES PIÈCES TENTE SONT INTERCHANGEABLES.

ROBLOCK è un gioco di costruzioni composto da molti pezzi differenti tra loro. È necessario unire bene i pezzi tra loro poiché durante il gioco alcune parti possono essere sollecitate a causa di movimenti di articolazione.

SUPERTRASFORMABILI
I ROBLOCK sono trasformabili poiché sono composti da normali pezzi TENTE. Questo permette di modificare i vari modelli seguendo la propria creatività. Per comporre nuovi modelli si possono usare pezzi di tutte le altre scatole di costruzioni della linea TENTE: Tente Mare, Tente Aria, Tente Cosmo.

TUTTI I PEZZI TENTE SONO INTERCAMBIABILI

ROBLOCK ist ein Baukasten, der eine ganze Menge verschiedener Teile enthält. Durch die Bewegung der Teile während des Spiels sind diese einer gewissen Belastung ausgesetzt, und deshalb empfiehlt es sich, die Steine sehr sorgfältig miteinander zu verbinden.

ROBLOCK sind aus normalen TENTE-Steinen zusammengestellt. Trotzdem kann man sie verändern. Daher ist es möglich, den Modellen eine andere Form zu geben und die eigenen Ideen zu verwirklichen. Hochinteressante Modelle kann man durch die Kombination mehrerer TENTE-Baukasten oder der Bau-Elemente von TENTE See, TENTE Luft und TENTE Weltraum erzielen.

ALLE TENTE BAU-ELEMENTE KÖNNEN MITEINANDER VERBAUT WERDEN.

